

MATLAB EXPO 2017

Parallel Computing with MATLAB and Simulink

Alka Nair
Application Engineer
MathWorks India Private Limited

Why Parallel Computing ?

- Size and complexity of analytical problems is growing across industries
- Need faster insight to bring competitive products to market quickly
- Hardware is becoming powerful: Leverage computational power of multicore desktops, GPUs, clusters



Key Takeaways

- Overcome challenges with MathWorks Parallel Computing Tools
 - Save engineering and research time and focus on results
 - Leverage computational power of broadly available hardware with minimal changes to your existing code
 - (Multicore Desktops, GPUs, Clusters)
 - Seamlessly scale from your desktop to clusters or the cloud
 - Speed-up analysis of Big Data using built-in parallel computing capabilities

Where is Parallel Computing Used?

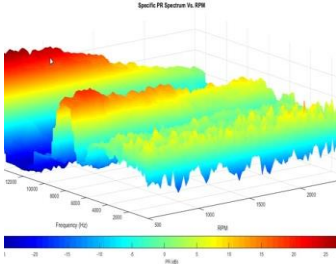

Bosch Develops Platform for Automotive Test Data Analysis and Visualization

Validation time **reduced by 40-50%**
3-4 months of development time saved

Heart Transplant Studies **4 weeks reduced to 5 days**



Lockheed Martin Builds Discrete-Event Model of Fleet Performance

Simulation time reduced **from months to hours**

20X faster simulation time
Linkage with Neural Network Toolbox



Carnegie Wave Energy Designs and Builds Wave Energy Farm

Sensitivity studies
accelerated 12x



Commerzbank Develops Production Software Systems for Calculating Derived Market Data

Implementation **time reduced by months**
Updates loaded 8X faster

Agenda

- Parallel computing paradigms in MATLAB and Simulink
- Accelerate applications with NVIDIA GPUs
- Scaling to clusters and clouds
- Summary

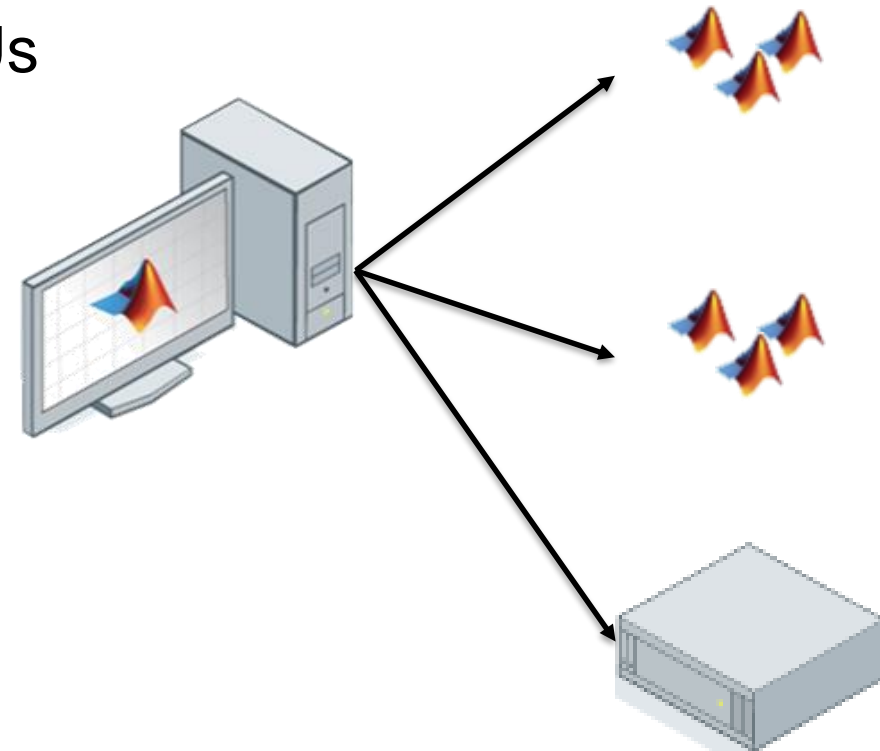

Classification learner demo

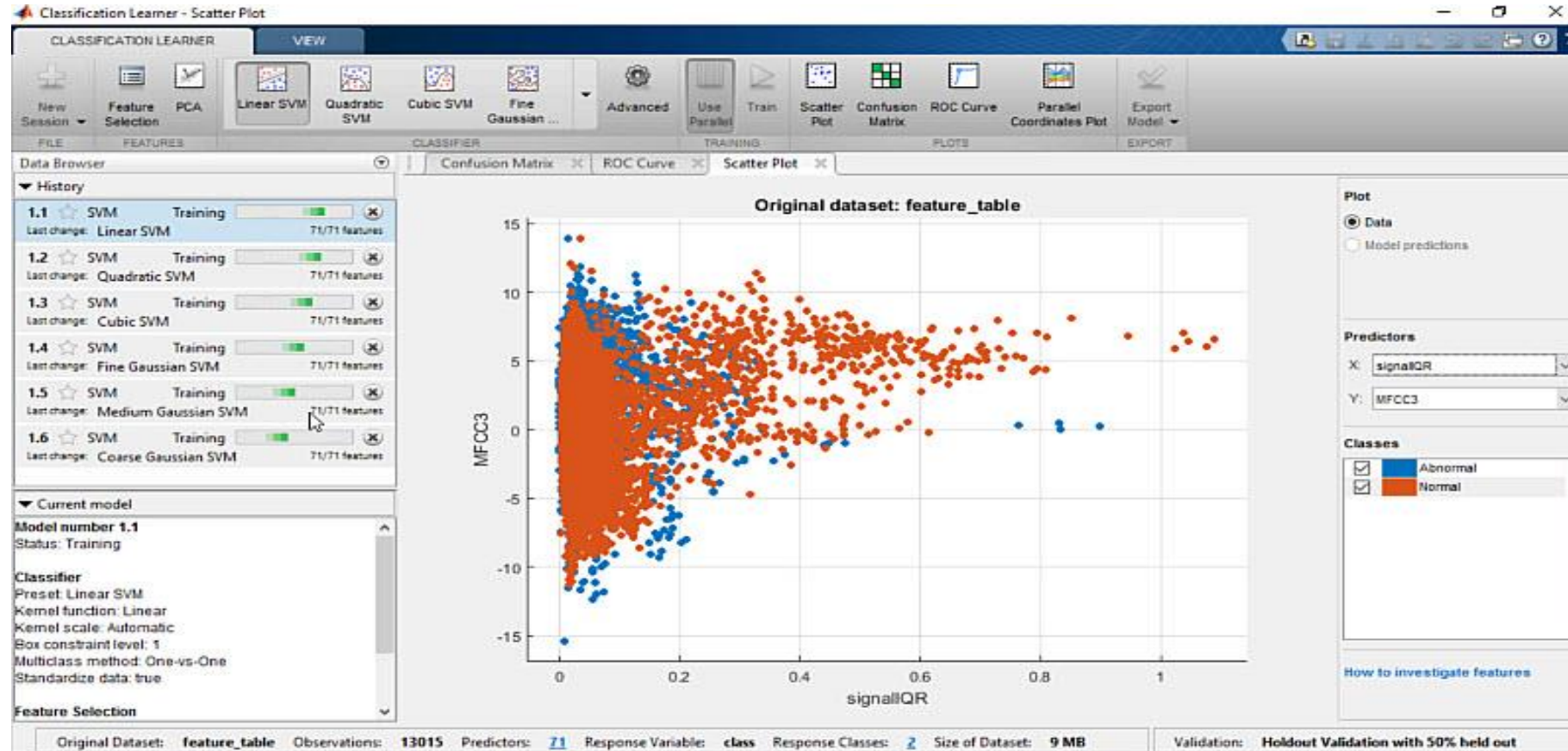

Parallel Computing Paradigm - Hardware

Multicore Desktops

Multicore Desktop

Parallel Pool

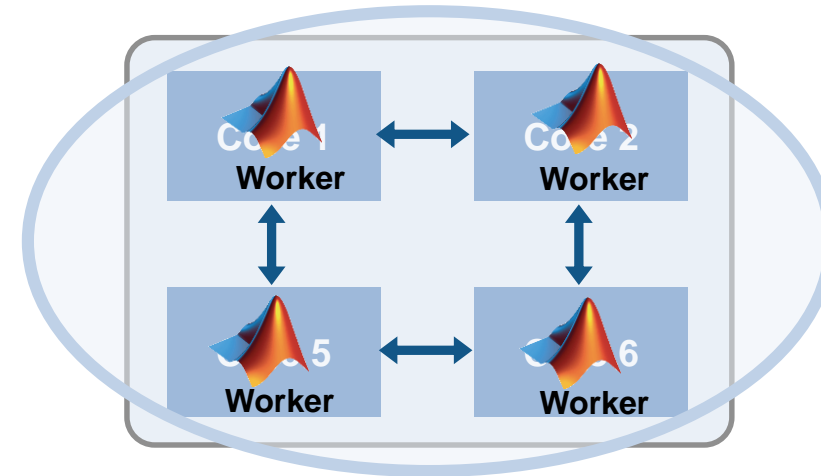
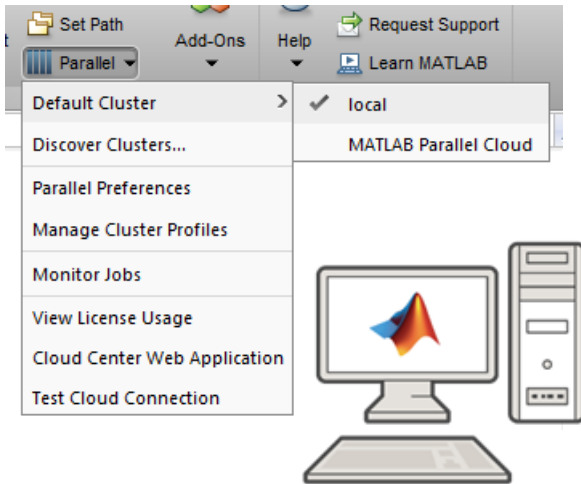

Parallel Computing Paradigm - Hardware

Cluster Hardware

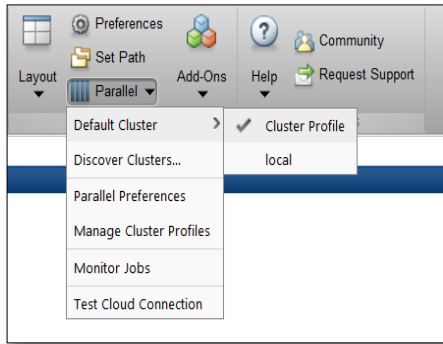

**MATLAB Desktop
(client)**



Cluster of computers



Cloud

Programming Parallel Applications – Programming Constructs

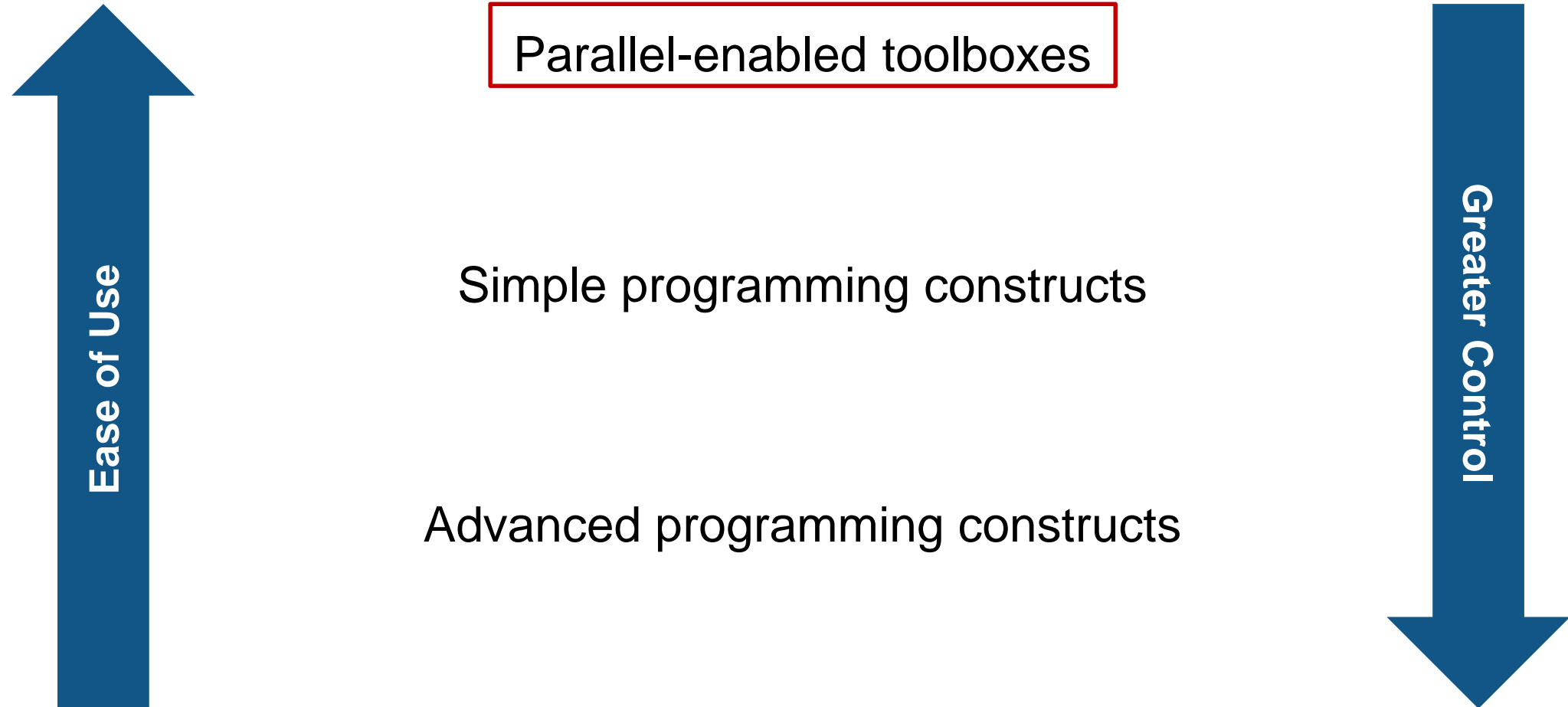

Parallel Computing: Neural Network Toolbox

```
%% Load data set
[x, t] = bodyfat_dataset;

%% Define the network
net1 = feedforwardnet(10);

%% Use parallel Computing to train the Network
net2 = train(net1, x, t, 'useParallel', 'yes');
y = net2(x, 'useParallel', 'yes');
```

Parallel-enabled Toolboxes (MATLAB® Product Family)

Enable parallel computing support by setting a flag or preference

Image Processing

Batch Image Processor, Block Processing, GPU-enabled functions



Original Image of Peppers

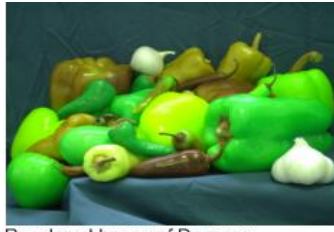

Recolored Image of Peppers

Statistics and Machine Learning

Resampling Methods, k-Means clustering, GPU-enabled functions

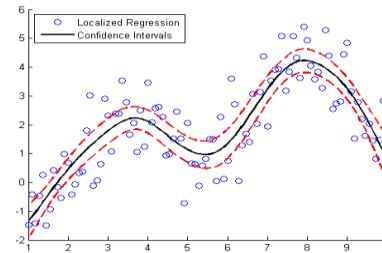

Neural Networks

Deep Learning, Neural Network training and simulation

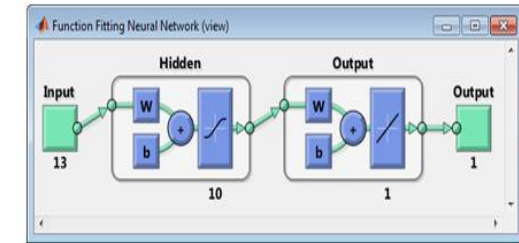

Signal Processing and Communications

GPU-enabled FFT filtering, cross correlation, BER

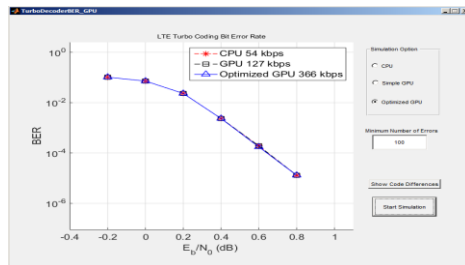

Computer Vision

Parallel-enabled functions in bag-of-words workflow

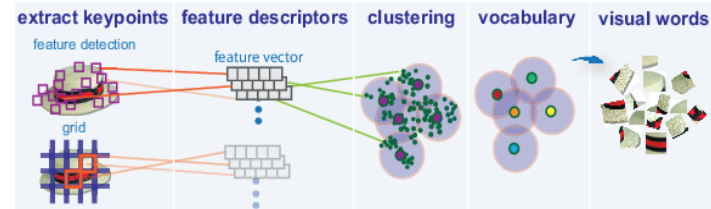

Optimization

Parallel estimation of gradients

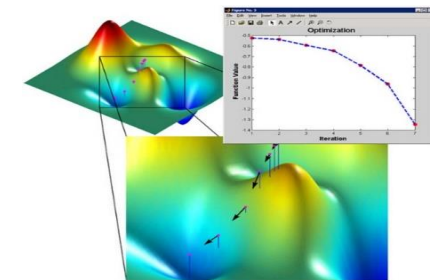

Parallel-enabled Toolboxes (Simulink® Product Family)

Enable parallel computing support by setting a flag or preference

Simulink Design Optimization

Response optimization, sensitivity analysis, parameter estimation

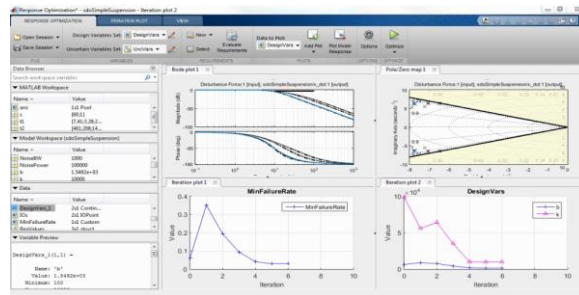

Simulink Control Design

Frequency response estimation

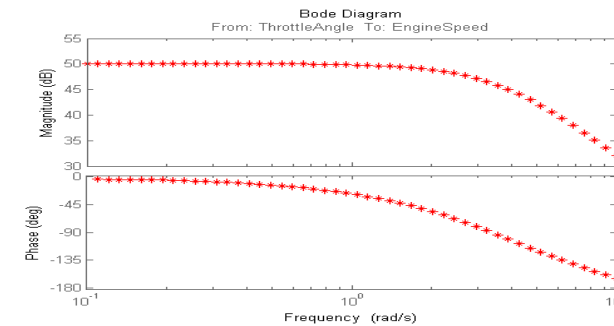

Communication Systems Toolbox

GPU-based System objects for Simulation Acceleration

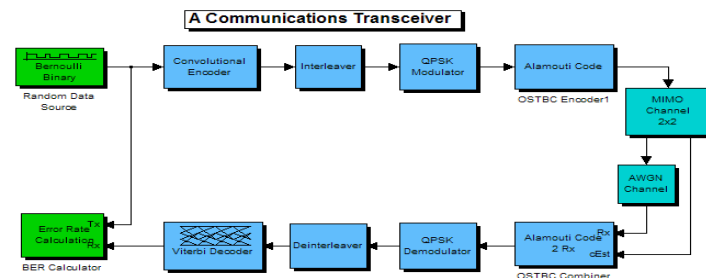

Simulink/Embedded Coder

Generating and building code

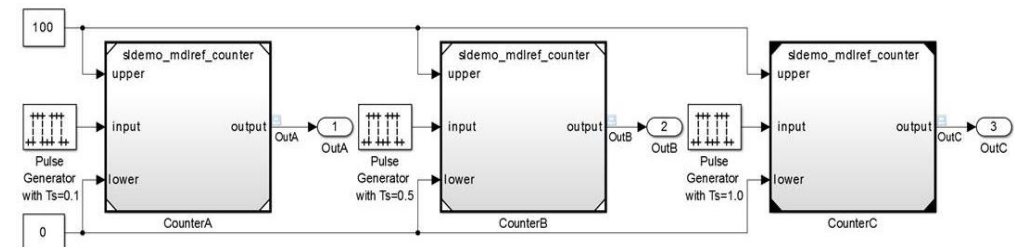

Data Intensive: Big Data support in MATLAB

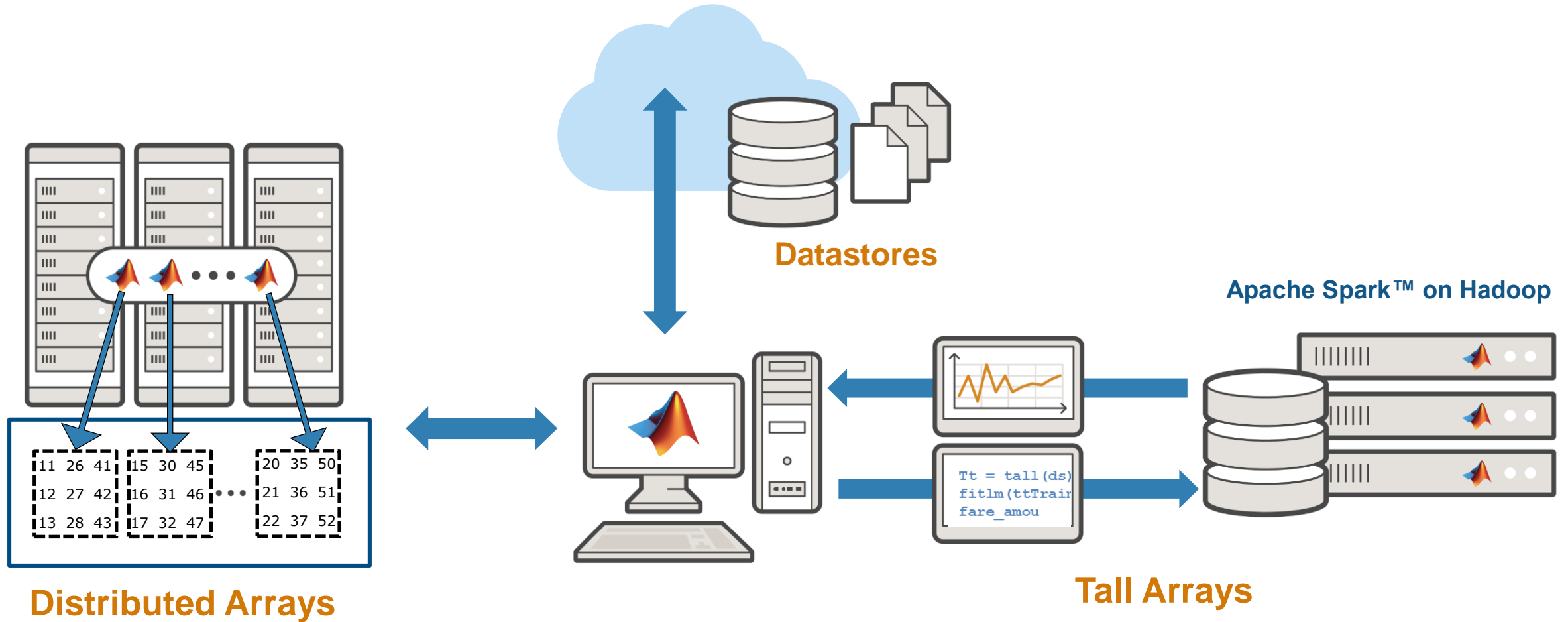

tall arrays R2016b

- With Parallel Computing Toolbox, process several “chunks” at once
- Can scale up to clusters with MATLAB Distributed Computing Server

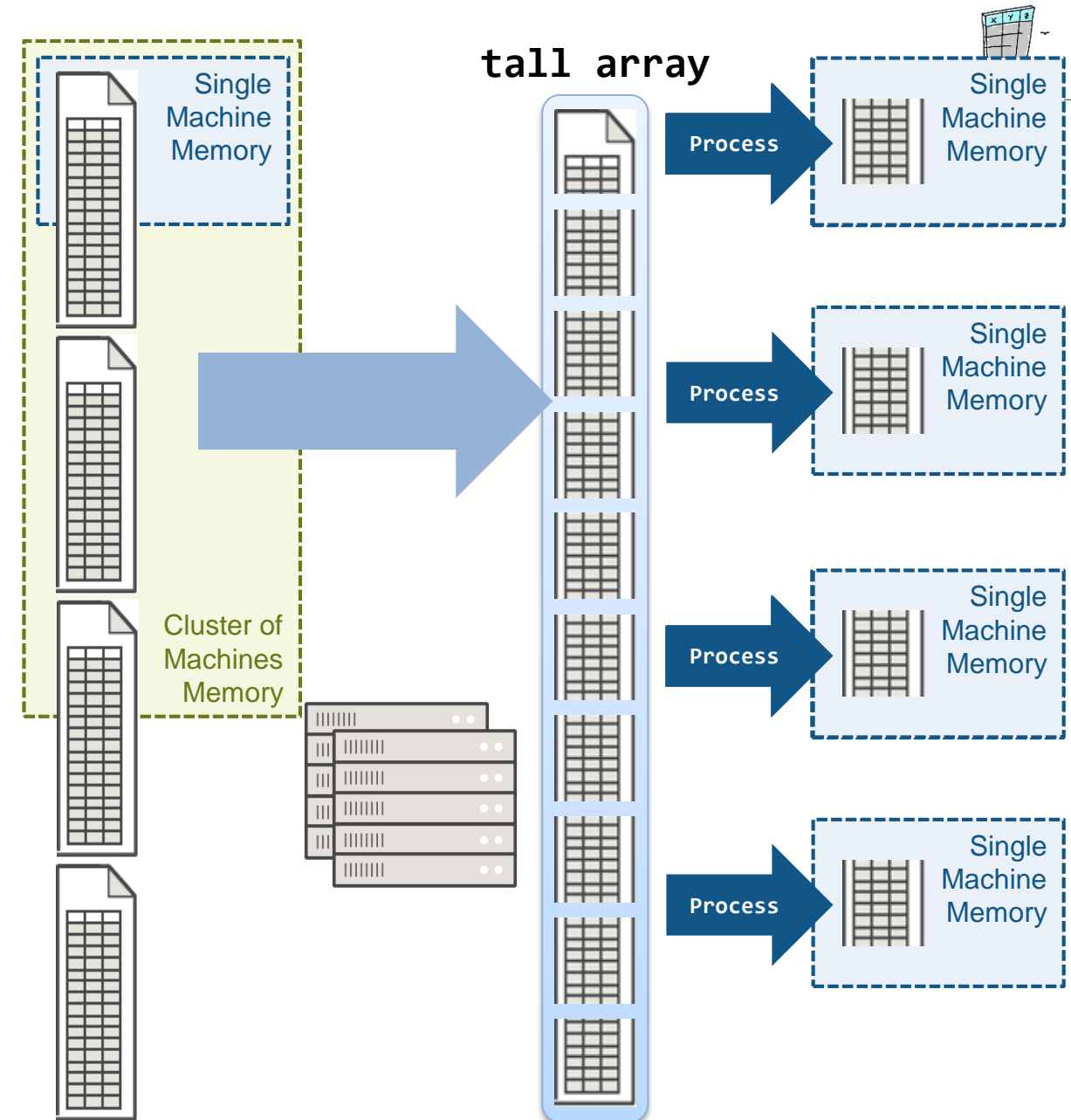

Using Tall Arrays

Local disk
Shared folders
Databases

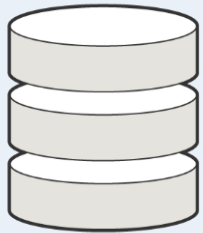

- **Tall arrays**
MATLAB
- **100's of functions supported**
MATLAB
Statistics and Machine Learning Toolbox
- **Run in parallel**
Parallel Computing Toolbox

- **Run in parallel on compute clusters**
MATLAB Distributed Computing Server

Compute Clusters



Spark + Hadoop

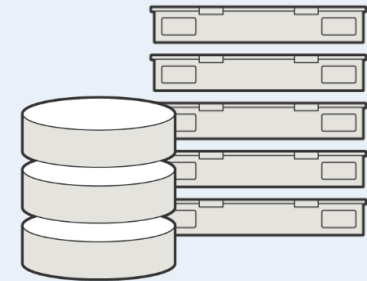

- **Run in parallel on Spark clusters**
MATLAB Distributed Computing Server
- **Deploy MATLAB applications as standalone applications on Spark clusters**
MATLAB Compiler



Programming Parallel Applications – Programming Constructs



Parallel-enabled toolboxes

Simple programming constructs
Eg. Parfor, Batch

Advanced programming constructs
Spm, createJob, labsend



Demo: Getting Data from a Web API

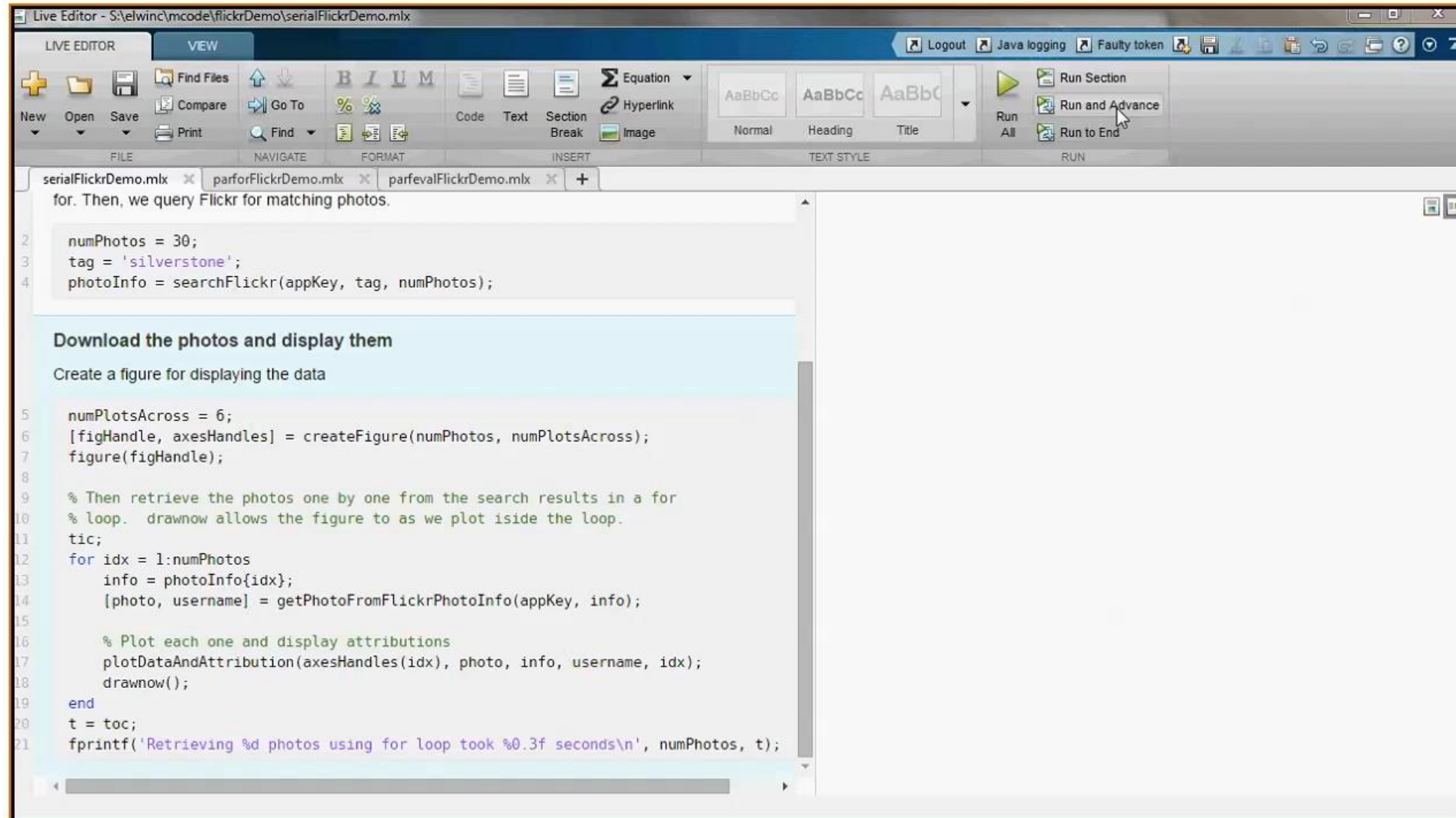

The screenshot shows the MATLAB Live Editor interface. The top toolbar includes options for 'Run Section', 'Run and Advance', and 'Run to End'. The main workspace contains a script with the following code:

```
for. Then, we query Flickr for matching photos.

2  numPhotos = 30;
3  tag = 'silverstone';
4  photoInfo = searchFlickr(appKey, tag, numPhotos);

Download the photos and display them
Create a figure for displaying the data

5  numPlotsAcross = 6;
6  [figHandle, axesHandles] = createFigure(numPhotos, numPlotsAcross);
7  figure(figHandle);
8
9  % Then retrieve the photos one by one from the search results in a for
10 % loop. drawnow allows the figure to as we plot inside the loop.
11 tic;
12 for idx = 1:numPhotos
13     info = photoInfo{idx};
14     [photo, username] = getPhotoFromFlickrPhotoInfo(appKey, info);
15
16     % Plot each one and display attributions
17     plotDataAndAttribution(axesHandles{idx}, photo, info, username, idx);
18     drawnow();
19 end
20 t = toc;
21 fprintf('Retrieving %d photos using for loop took %0.3f seconds\n', numPhotos, t);
```

Demo: Getting Data from a Web API using parfor

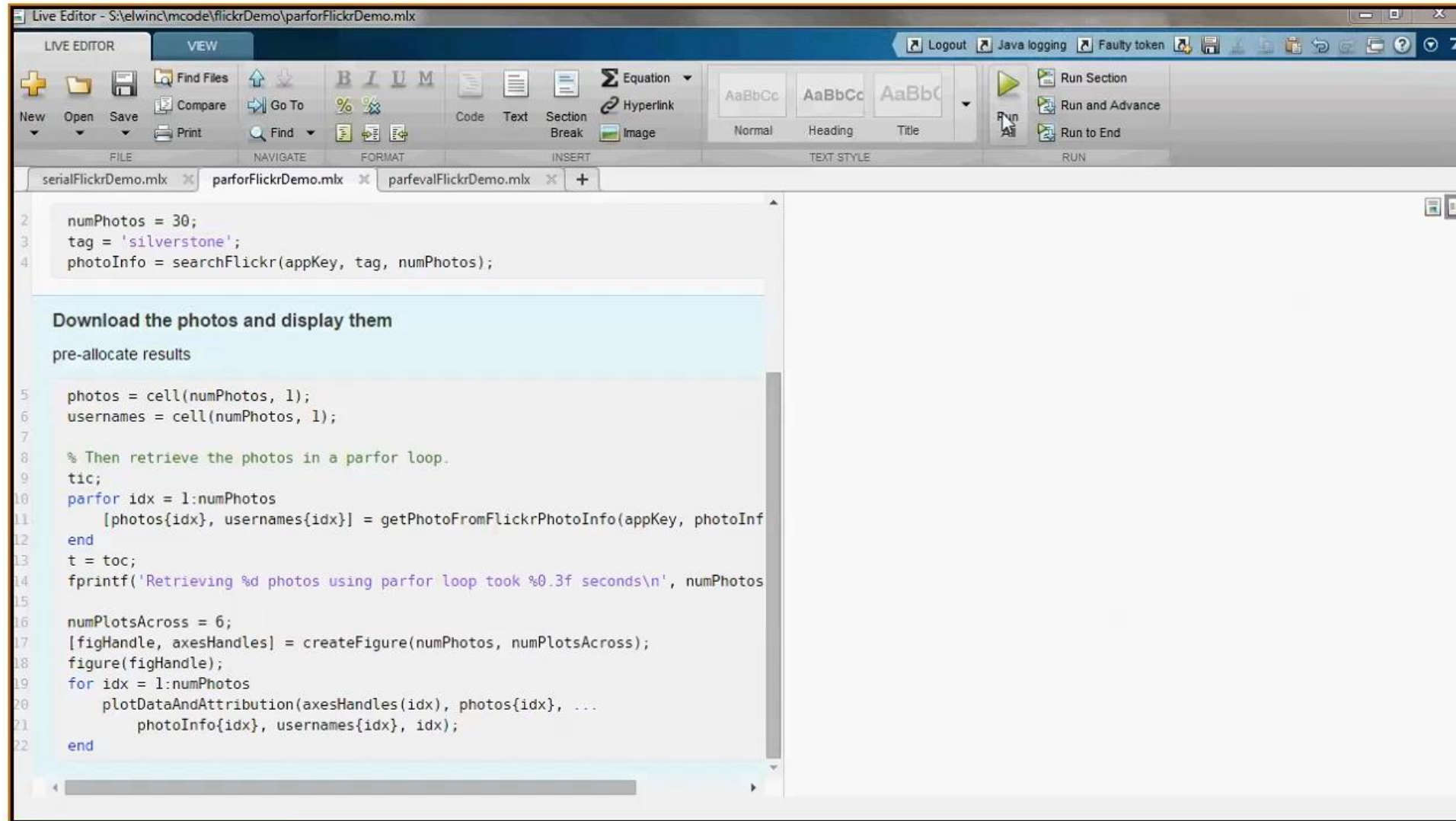

The screenshot shows the MATLAB Live Editor interface. The title bar indicates the file path: `S:\elwinc\mcode\flickrDemo\parforFlickrDemo.mlx`. The interface includes a menu bar with options like 'LIVE EDITOR', 'VIEW', 'Logout', 'Java logging', and 'Faulty token'. Below the menu bar is a toolbar with icons for file operations (New, Open, Save, Find Files, Compare, Print, Go To, Find), formatting (B, I, U, M, Code, Text, Section Break, Image), and execution (Run Section, Run and Advance, Run to End). The main workspace displays a MATLAB script with the following code:

```
2 numPhotos = 30;
3 tag = 'silverstone';
4 photoInfo = searchFlickr(appKey, tag, numPhotos);

Download the photos and display them
pre-allocate results

5 photos = cell(numPhotos, 1);
6 usernames = cell(numPhotos, 1);
7
8 % Then retrieve the photos in a parfor loop.
9 tic;
10 parfor idx = 1:numPhotos
11     [photos{idx}, usernames{idx}] = getPhotoFromFlickrPhotoInfo(appKey, photoInf
12 end
13 t = toc;
14 fprintf('Retrieving %d photos using parfor loop took %0.3f seconds\n', numPhotos
15
16 numPlotsAcross = 6;
17 [figHandle, axesHandles] = createFigure(numPhotos, numPlotsAcross);
18 figure(figHandle);
19 for idx = 1:numPhotos
20     plotDataAndAttribution(axesHandles(idx), photos{idx}, ...
21         photoInfo{idx}, usernames{idx}, idx);
22 end
```

Explicit Parallelism: Independent Tasks or Iterations

Simple programming constructs using `parfor`, `parfeval`

Examples: parameter sweeps, Monte Carlo simulations

No dependencies or communications between tasks

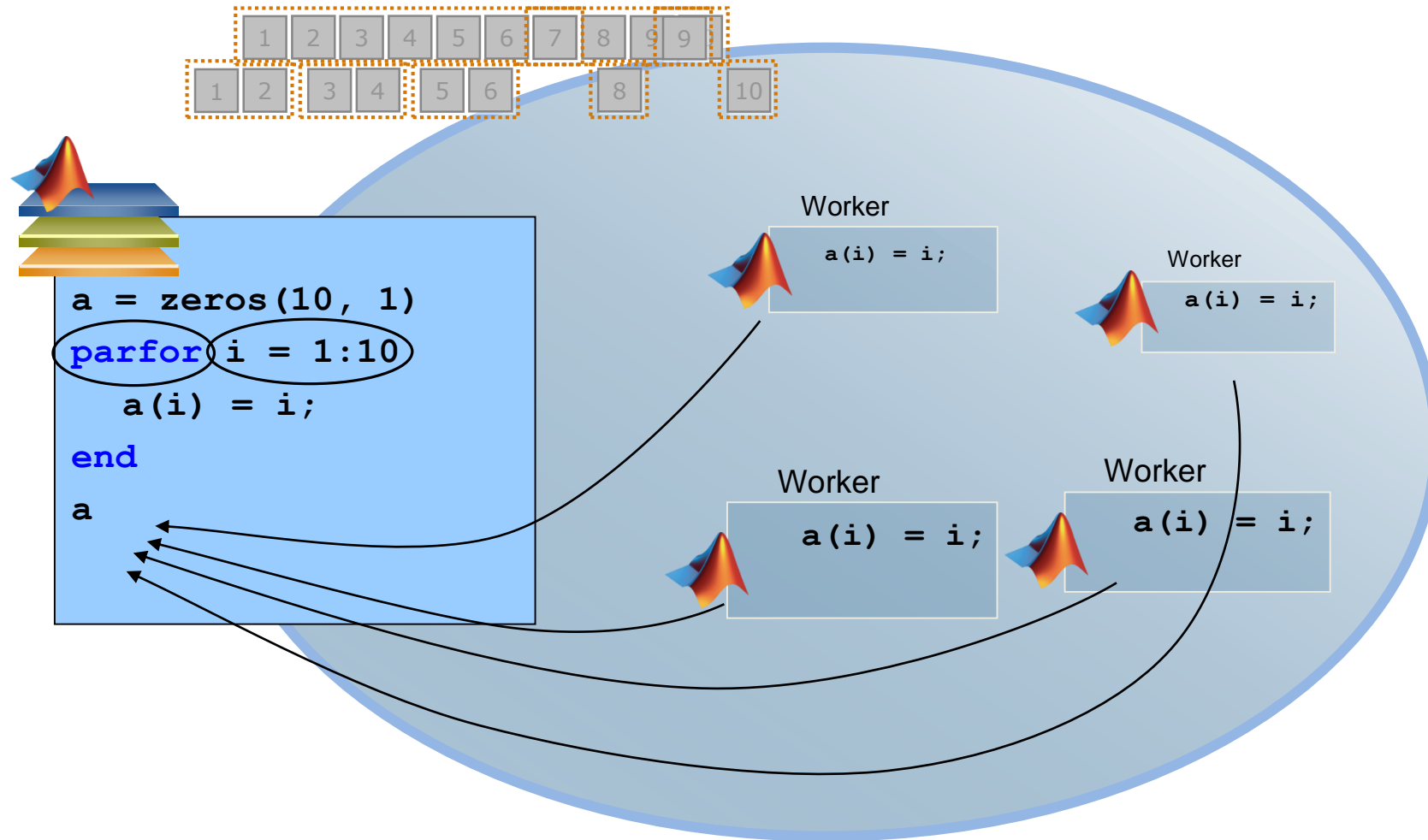

Independent Tasks or Iterations

Simple programming constructs using `parfor`, `parfeval`

- Examples: parameter sweeps, Monte Carlo simulations
- No dependencies or communications between tasks

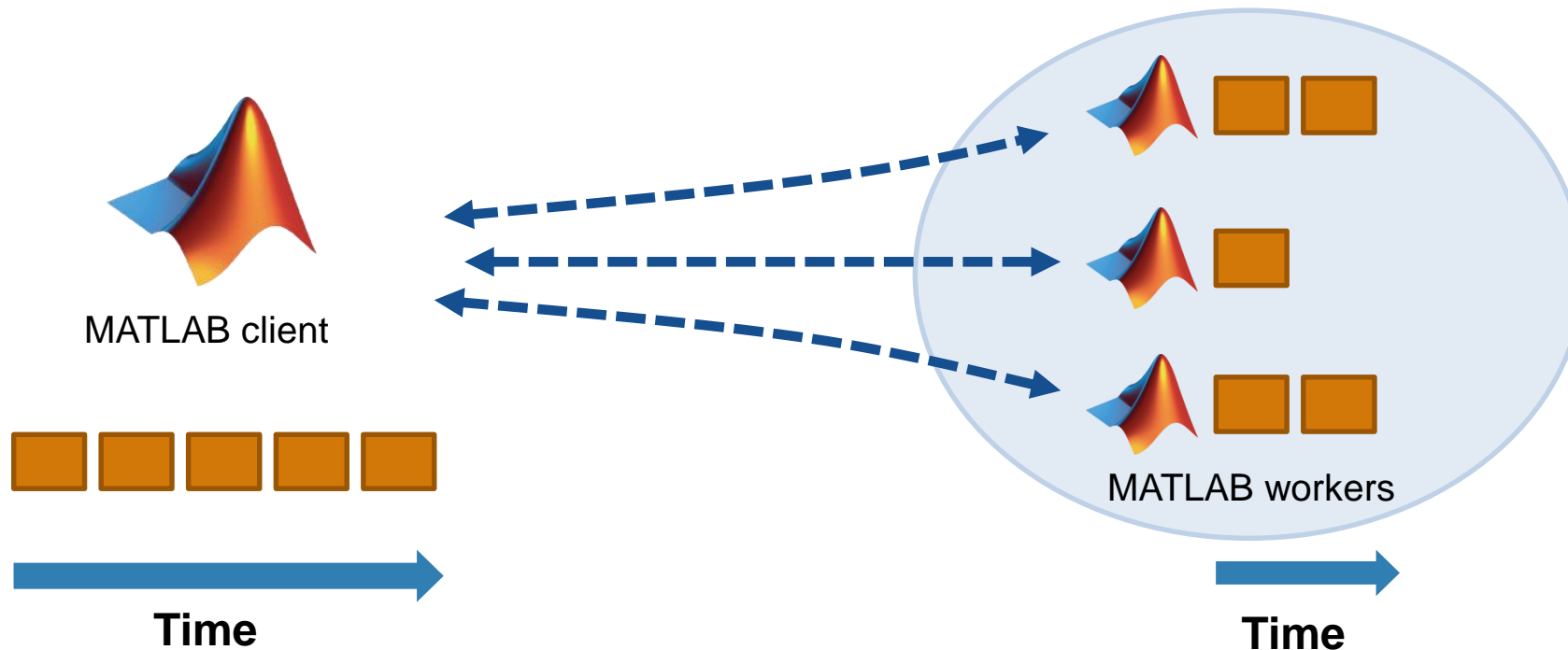

Leverage Parallel Computing for Simulink

➤ Reduce the total amount of time it takes to...

•Run multiple independent simulations (E.g. Parameter sweeps, Monte Carlo Analysis)

Update models containing large model reference hierarchies

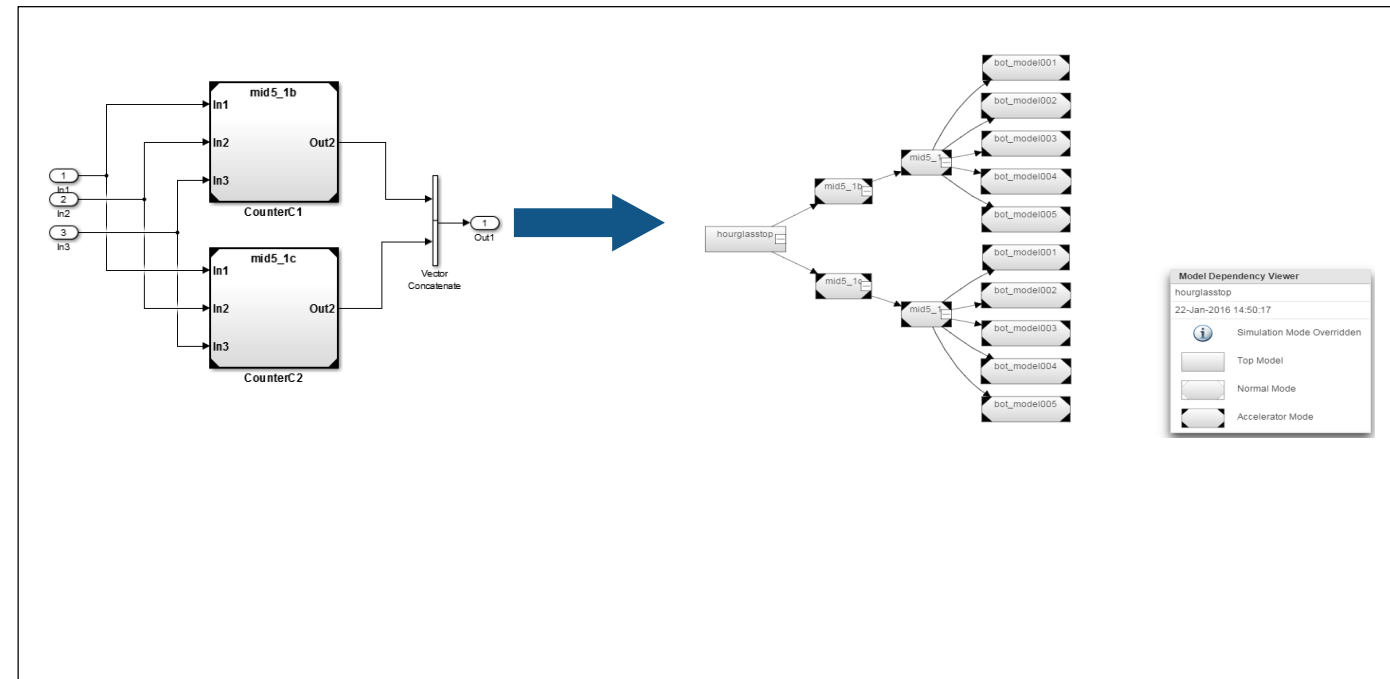
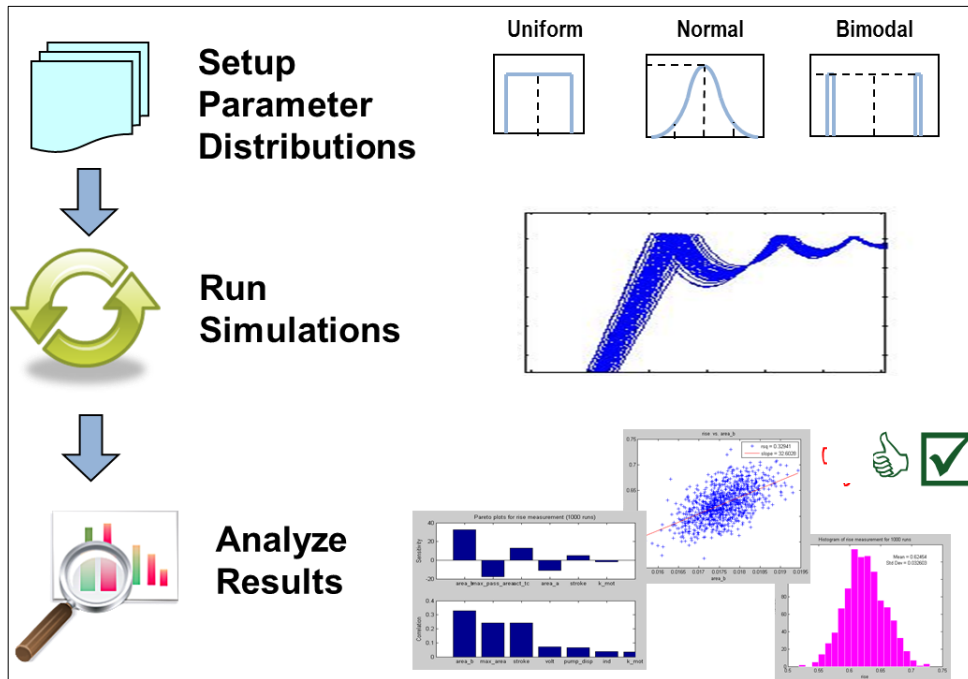

Parallel Simulations using Simulink and Parsim

Directly run multiple parallel simulations from the parsim command

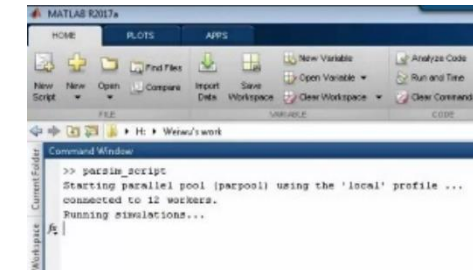
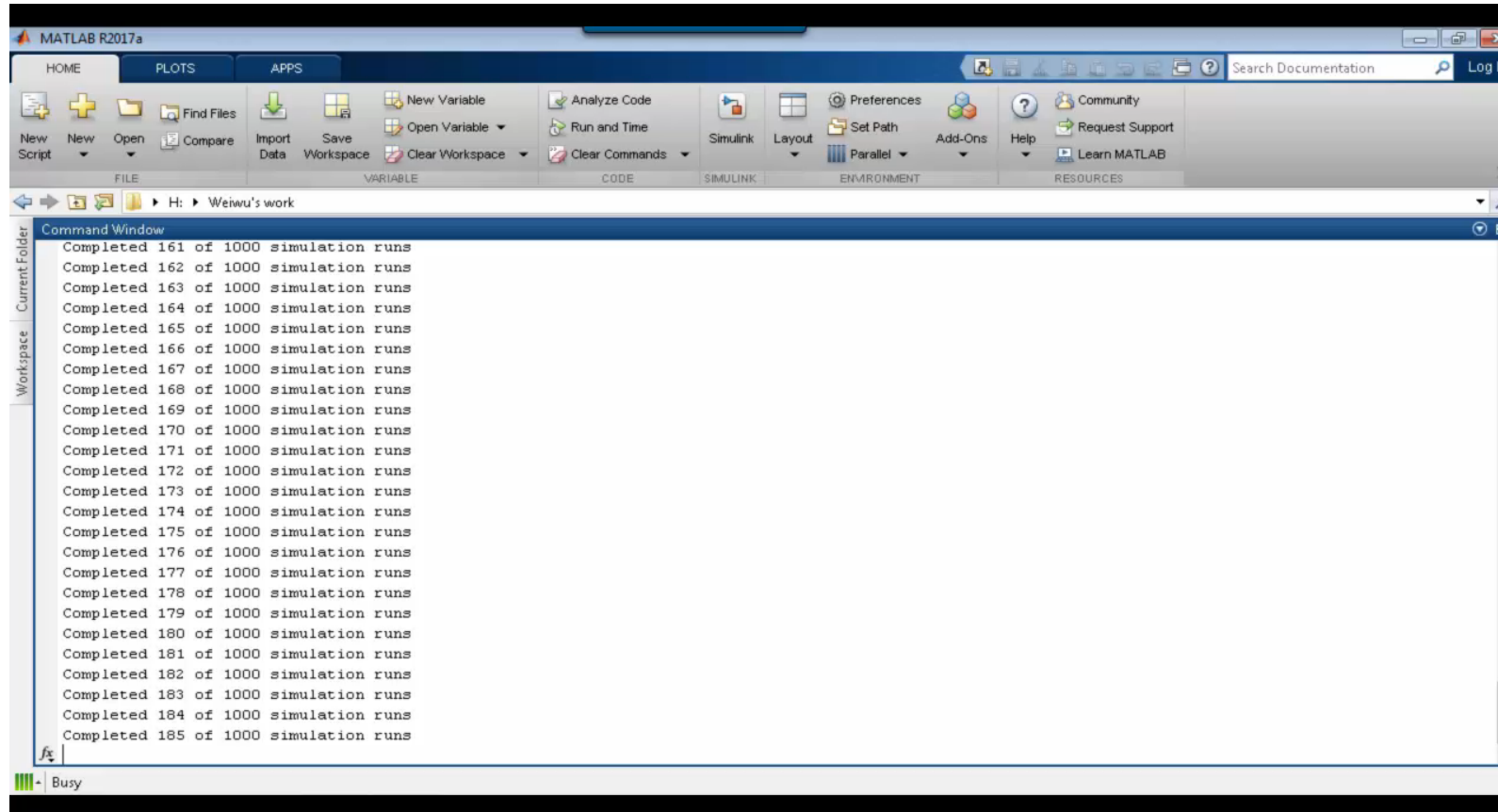
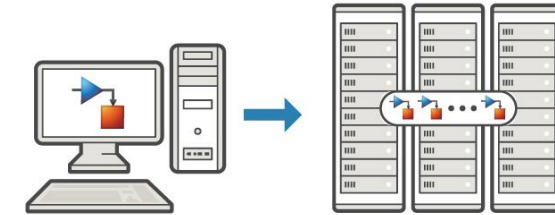

We manage the parallel setup so customers can focus on their simulations

- Enables customers to easily use Simulink with parallel computing
- Simplifies customers' large simulation runs and improves their productivity

Programming Parallel Applications – Programming Constructs



Parallel-enabled toolboxes

Simple programming constructs
Eg. Parfor, Batch

Advanced programming constructs
spmd, createJob, labsend



Agenda

- Parallel computing in MATLAB and Simulink
- Accelerate applications with NVIDIA GPUs
- Scaling to clusters and clouds
- Summary

Example 3: Solving 2D Wave Equation

GPU Computing

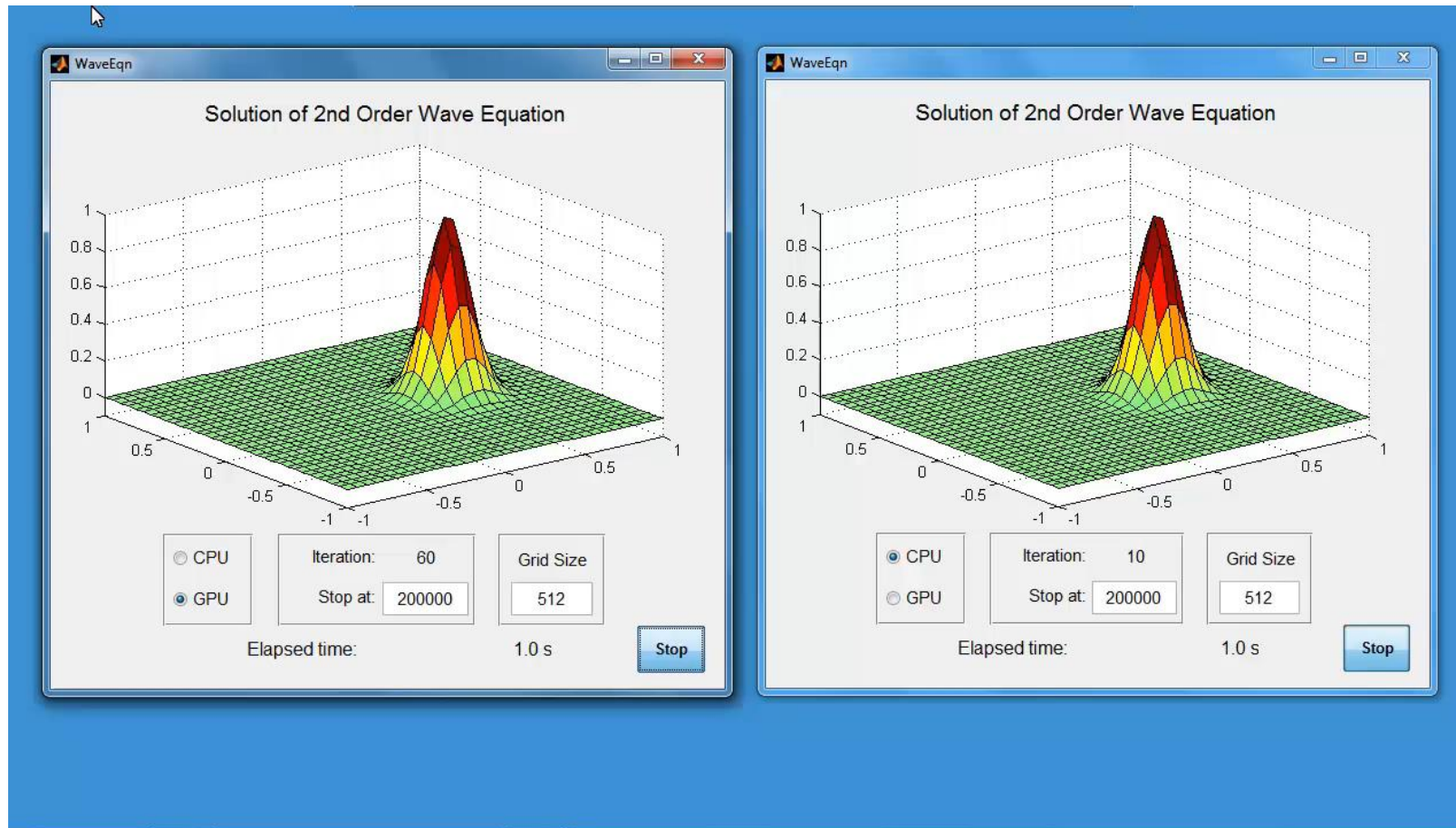

Example: Solving 2D Wave Equation

GPU Computing

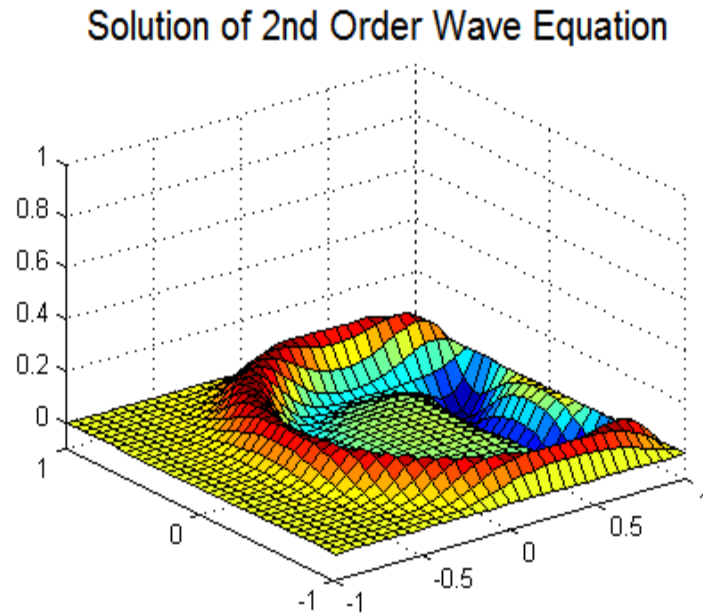

$$\frac{\partial^2 u}{\partial t^2} = \frac{\partial^2 u}{\partial x^2} + \frac{\partial^2 u}{\partial y^2}$$

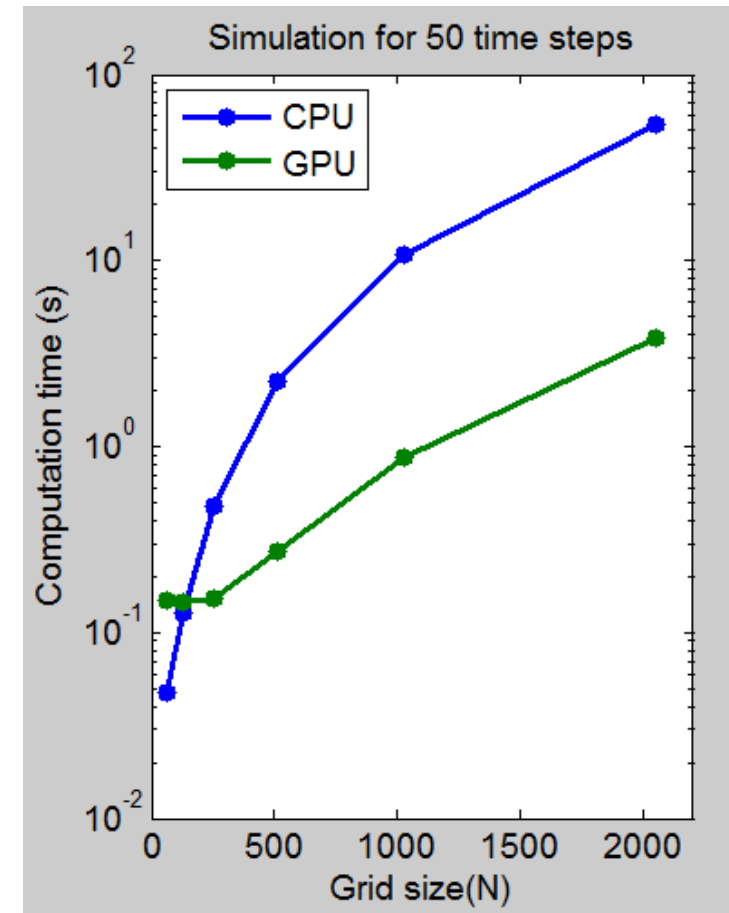

Intel Xeon Processor W3690 (3.47GHz),
NVIDIA Tesla K20 GPU

Parallel Computing Paradigm

Going Parallel: GPUs

Using NVIDIA GPUs

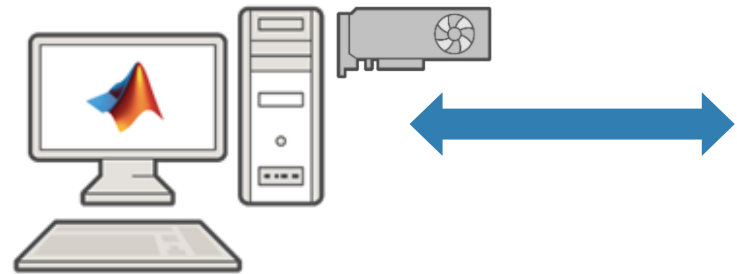

**MATLAB Desktop
(client)**

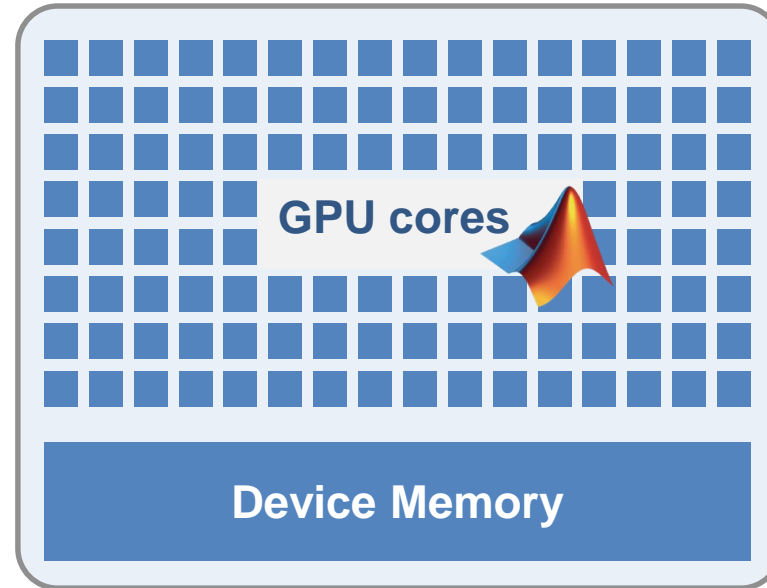

Performance Gain with More Hardware

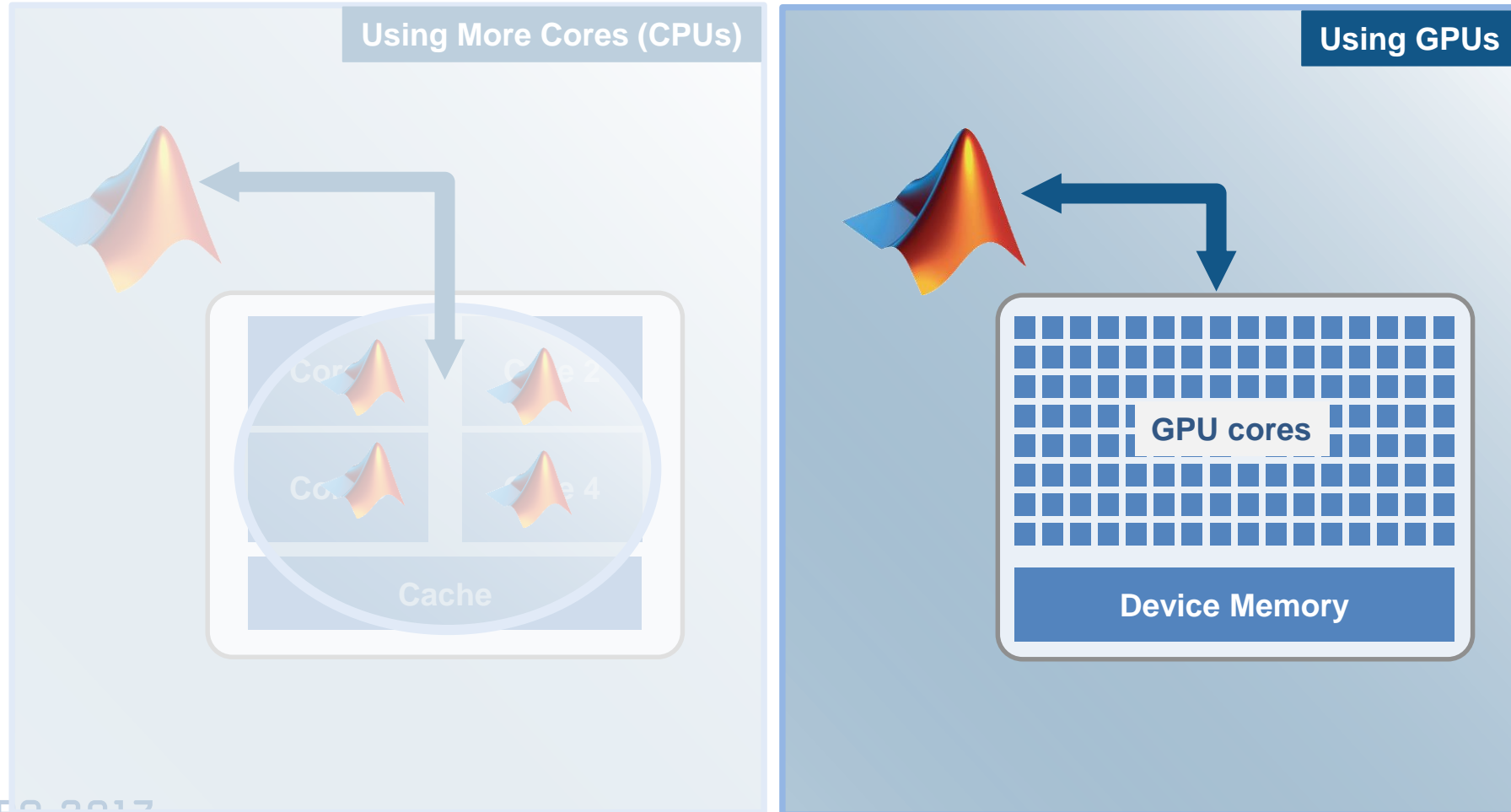

Speed-up using NVIDIA GPUs

- Ideal Problems
 - Massively Parallel and/or Vectorized operations
 - Computationally Intensive
 - Algorithm consists of supported functions
 - 300+ GPU-enabled MATLAB functions
 - Additional GPU-enabled Toolboxes
 - Neural Networks
 - Image Processing
 - Communications
 - Signal Processing
- [Learn More](#)

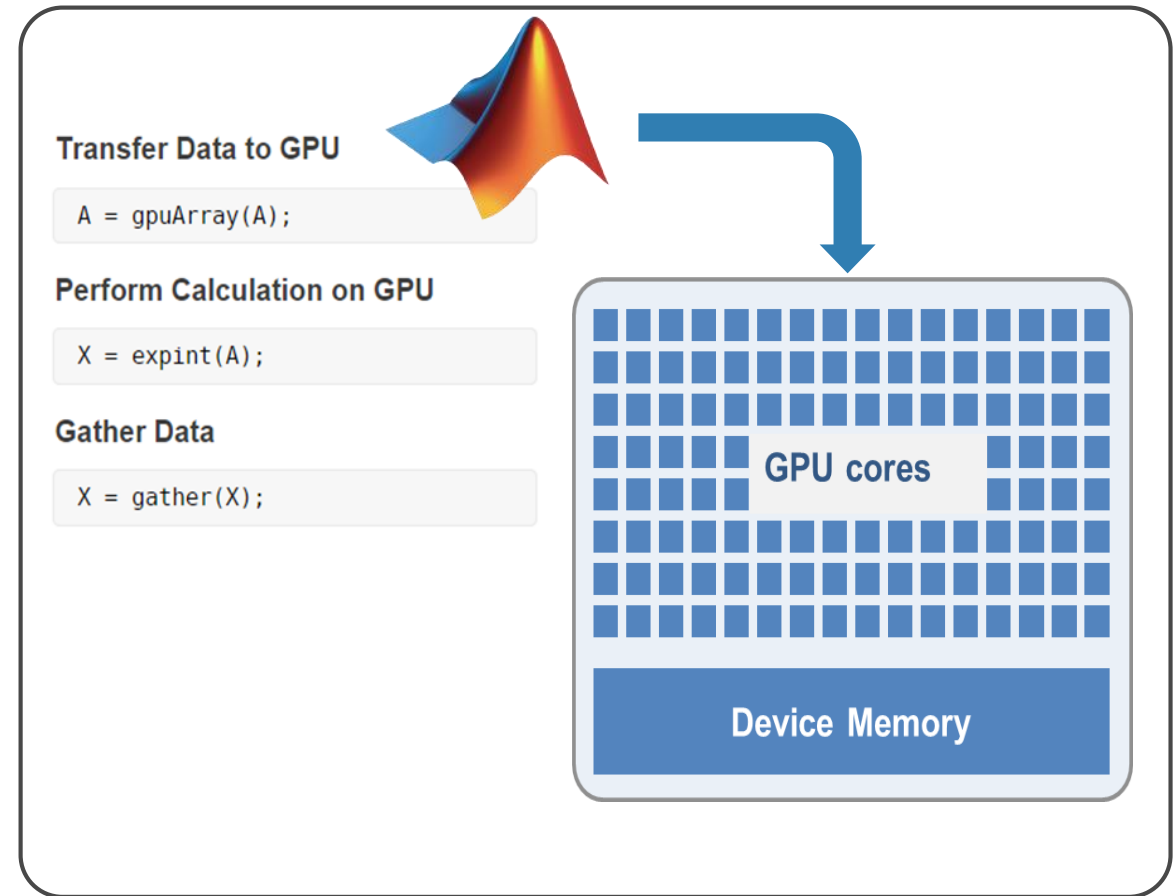

Signal Processing – Acoustic Data Analysis

NASA Langley Research

Goal: Accelerate the analysis of sound recordings from wind tunnel tests of aircraft components

Challenges

- Legacy code took 40 mins to analyze single wind tunnel test data
- Reduce processing time to make on-the-fly decisions and identify hardware problems



[Learn More](#)

Why GPU Computing

- Computations completed 40 times faster.

*“Many operations we perform, including FFTs and matrix multiplication, are **GPU-enabled MATLAB functions** .Once we developed the initial MATLAB code for CPU execution, it took 30 minutes to get our algorithm working on the GPU—**no low-level CUDA programming** was needed. The addition of GPU computing with Parallel Computing Toolbox cut it to **under a minute**, with most of that time spent on data transfer”*

Agenda

- Parallel computing in MATLAB and Simulink
- Accelerate applications with NVIDIA GPUs
- **Scaling to clusters and clouds**
- Summary

Scaling to a computer cluster

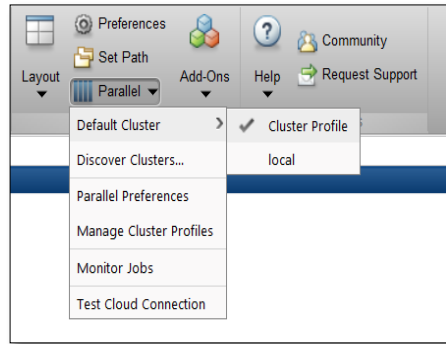

**MATLAB Desktop
(client)**

Cluster of computers

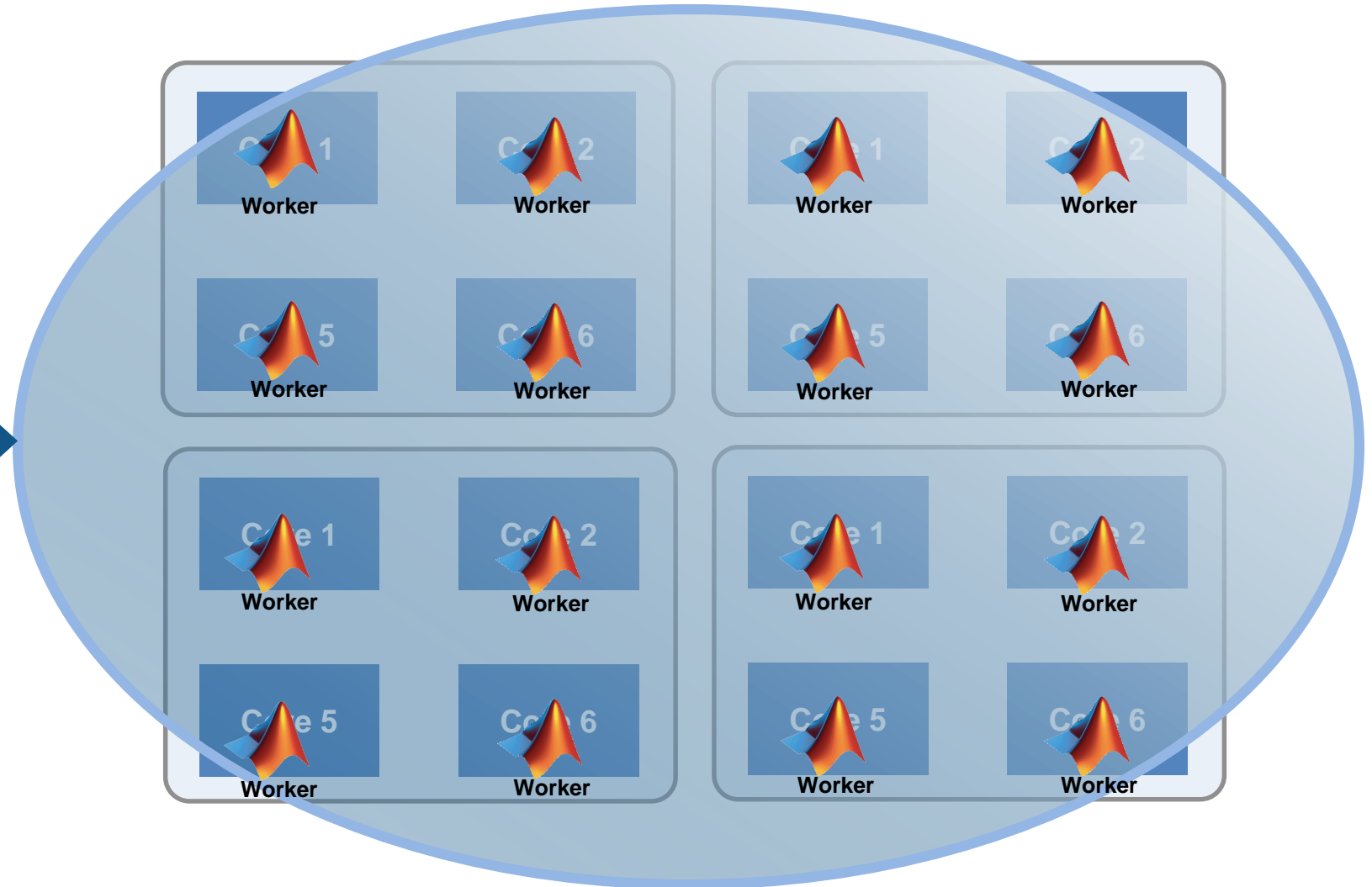

Why parallel computing matters

Scaling case study with a compute cluster

$$M\ddot{x} + C\dot{x} + Kx = F$$

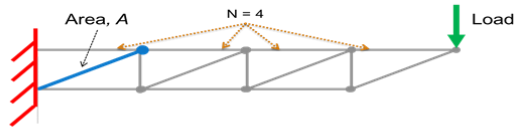

Log of Maximum Y Deflection
(12 segments)

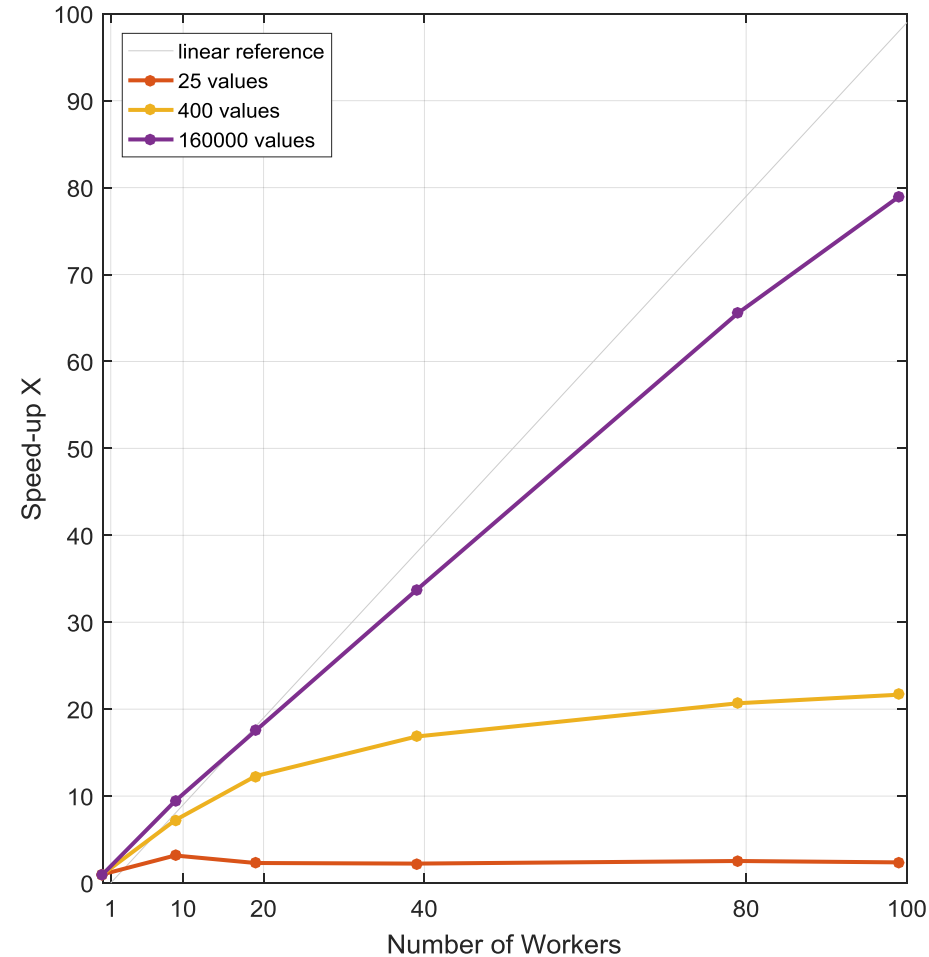
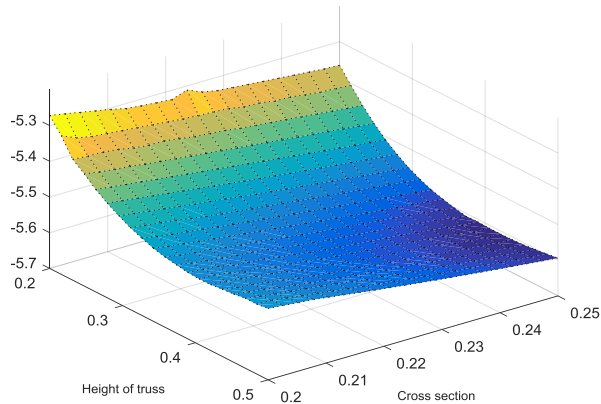

| Workers in pool | Compute time (minutes) | | |
|-----------------|------------------------|------------|-----------|
| | 160e3 values | 400 values | 25 values |
| 1 | 140 | 0.38 | 0.03 |
| 10 | 15 | 0.05 | 0.01 |
| 20 | 8.0 | 0.03 | 0.01 |
| 40 | 4.2 | 0.02 | 0.01 |
| 80 | 2.1 | 0.02 | 0.01 |
| 100 | 1.8 | 0.02 | 0.01 |

Processor: Intel Xeon E5-class v2
16 physical cores per node
MATLAB R2016a

Scale Up to Clusters, Grids and Clouds

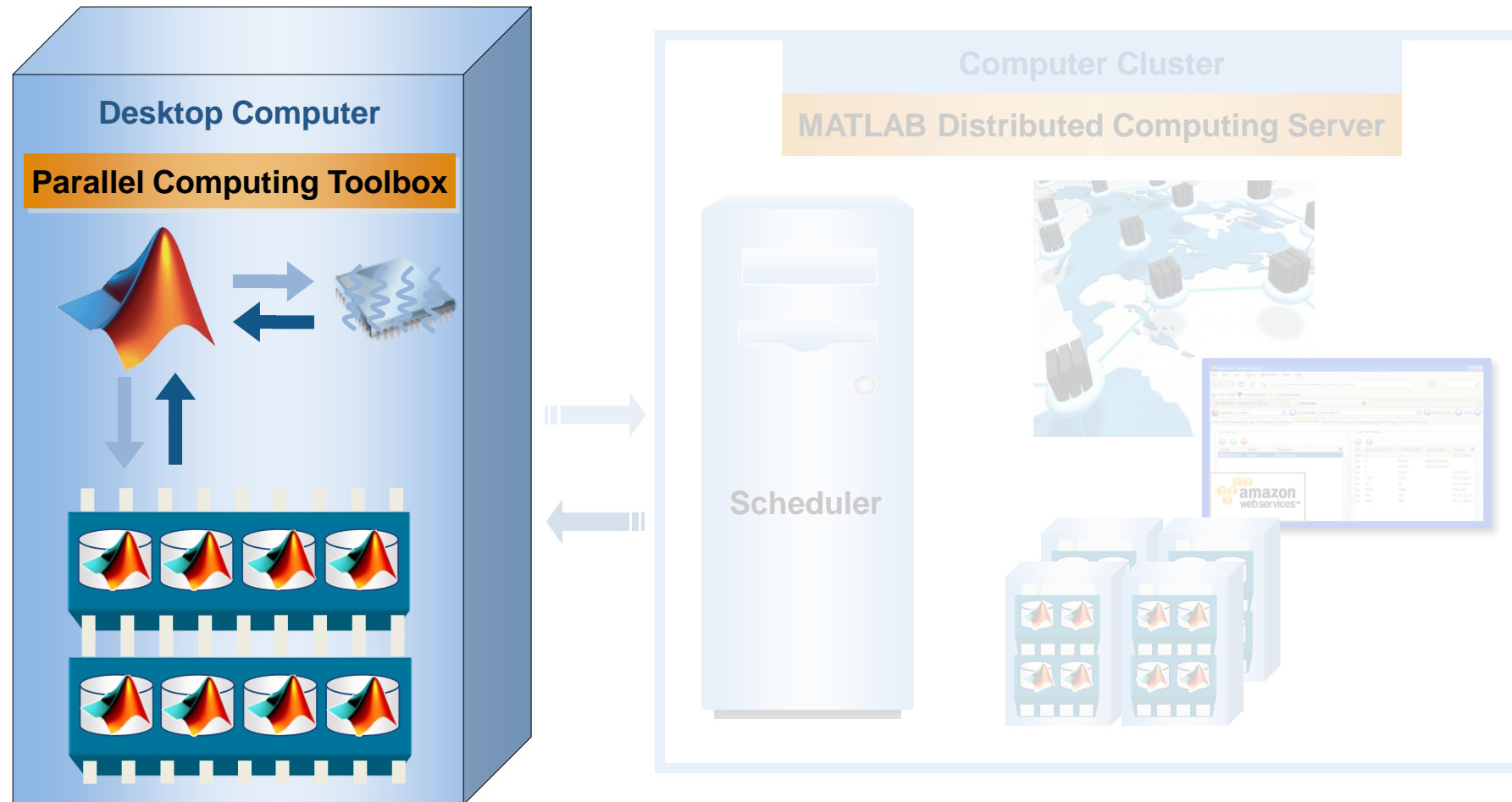

Offload and Scale Computations with batch

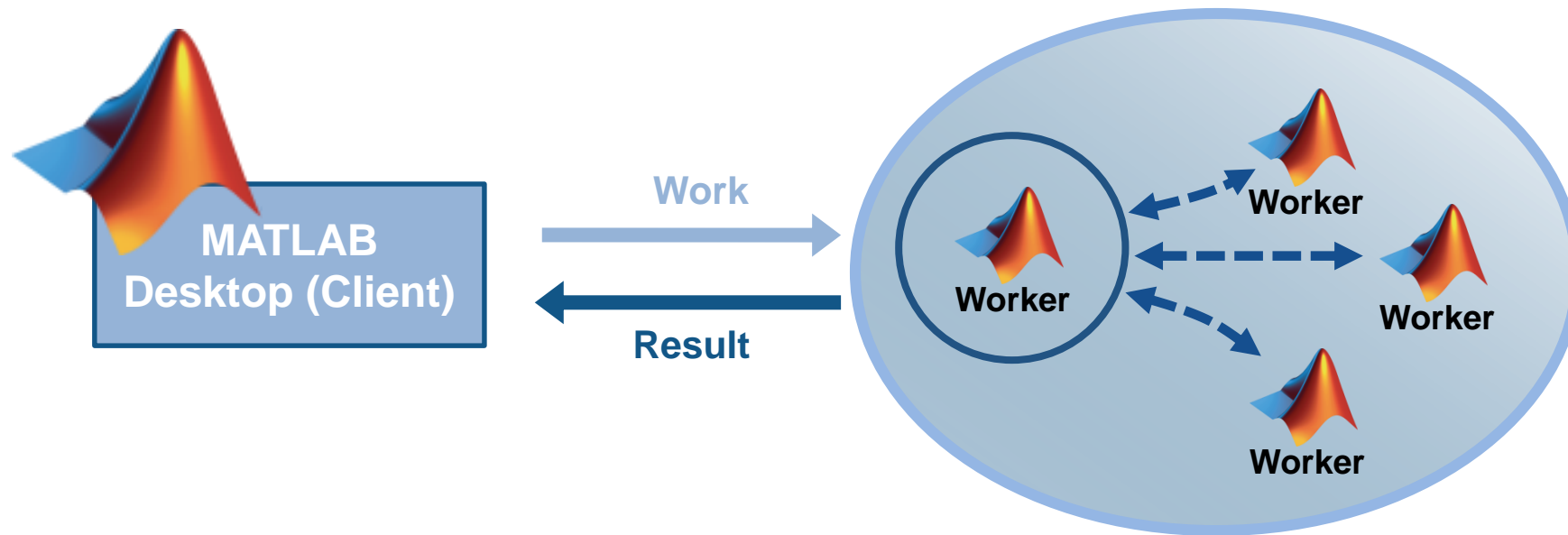

```
batch(..., 'Pool', ...)
```

Scale your applications beyond the desktop

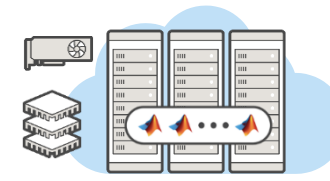
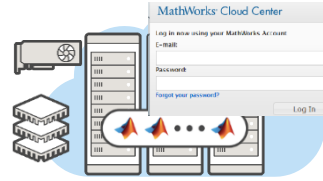
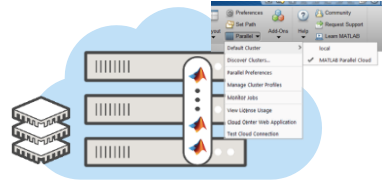

| Option | Parallel Computing Toolbox | MATLAB Parallel Cloud | MATLAB Distributed Computing Server for Amazon EC2 | MATLAB Distributed Computing Server for Custom Cloud | MATLAB Distributed Computing Server |
|-----------------|----------------------------|-------------------------------------|--|--|-------------------------------------|
| Description | Explicit desktop scaling | Single-user, basic scaling to cloud | Scale to EC2 with some customization | Scale to custom cloud | Scale to clusters |
| Maximum workers | No limit | 16 | 256 | No limit | No limit |
| Hardware | Desktop | MathWorks Compute Cloud | Amazon EC2 | Amazon EC2, Microsoft Azure, Others | Any |
| Availability | Worldwide | United States and Canada | United States, Canada and other select countries in Europe | Worldwide | Worldwide |

Summary and Takeaways

- **Speed up your MATLAB and Simulink applications without being an expert**
 - Reduce computation time by using more cores or accessing Graphical Processing Units
- **Leverage the Parallel Computing Toolbox to**
 - Reduce Computation Time: `parfor`, `gpuArray`, `parsim`
 - Offload and Scale Computations: `batch`
- **Speed up Big Data Analytics**
 - Using `datastore` and `tall` or `distributed` arrays
- **Develop parallel applications on the desktop and scale to clusters seamlessly**

What's new in 16b and 17a?

R2016b

- `ta11` array support for big data
- Measure data sent to workers using `ticBytes` and `tocBytes`
- Cloud offerings with K80-equipped GPUs

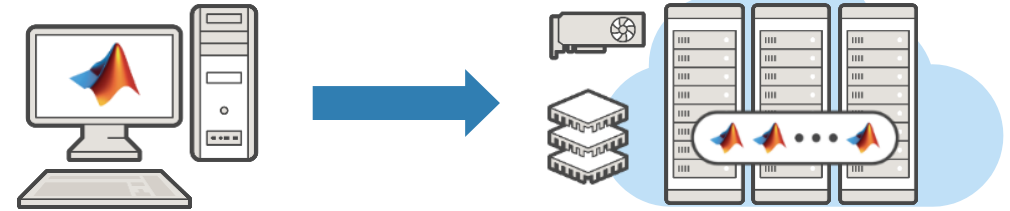

R2017a

- Simplified parallel Simulink simulations using `parsim`
- Send data to client using `DataQueue` and `PollableDataQueue`
- Train a single deep learning network with multiple CPUs or multiple GPUs

MathWorks Training Offerings

MATLAB Programming Techniques

INTERMEDIATE

This two-day course covers details of performance optimization as well as tools for writing, debugging, and profiling code. Topics include:

- Creating robust applications
- Structuring code
- Structuring data
- Creating custom toolboxes

Prerequisites: *MATLAB Fundamentals*

Parallel Computing with MATLAB

INTERMEDIATE

This two-day course shows how to use Parallel Computing Toolbox™ to speed up existing code and scale up across multiple computers using MATLAB Distributed Computing Server™ (MDCS). Attendees who are working with long-running simulations, or large data sets, will benefit from the hands-on demonstrations and exercises in the course. Topics include:

- Parallel for-loops
- Offloading execution
- Working with clusters
- Distributing and processing large data sets
- GPU computing

Prerequisites: *MATLAB Fundamentals*

<http://www.mathworks.com/services/training/>

Learn Further

- <https://www.mathworks.com/solutions/parallel-computing.html>
- <https://www.mathworks.com/help/distcomp/>
- <https://www.mathworks.com/help/distcomp/examples.html>



Accelerating the pace of engineering and science

Speaker Details

Email: Alka.Nair@mathworks.in

Contact MathWorks India

Products/Training Enquiry Booth

Call: 080-6632-6000

Email: info@mathworks.in

Your feedback is valued.

Please complete the feedback form provided to you.

